

- LEGEND:
- APPROACH TO PROPERTY
 - SIDEWALK
 - CURB AND GUTTER

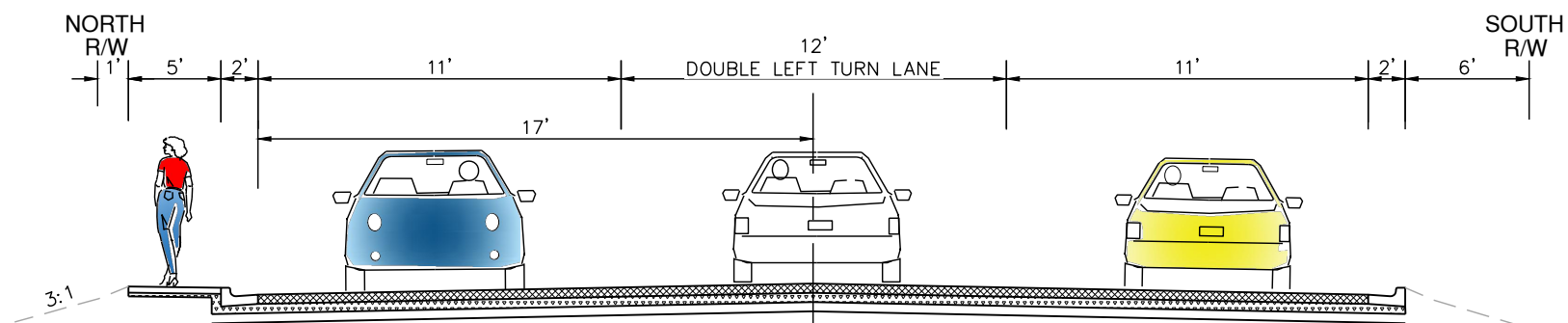

DESCRIPTION			
NO.	DATE	BY	DESCRIPTION

DESIGNED TAE
DESIGN CHECKED AW
DETAILED TAE
DRAWING CHECKED AW

SCALES SHOWN ARE FOR 11" X 17" PRINTS ONLY
CADD FILE NAME 20633 PUBLIC INVOLVEMENT
DRAWING DATE MAY 2020

**IDAHO
TRANSPORTATION
DEPARTMENT**

HMH engineering

PROJECT NO. A020(633)

PUBLIC PROJECT OVERVIEW BURLEY AVE US-30 TO FRUITLAND AVE

English
COUNTY TWIN FALLS
KEY NUMBER 20633
SHEET 7 OF 14

**NOT
APPROVED
PRELIMINARY
FOR
CONSTRUCTION**